

MACHINES CAROTTAGE

UTILISATION

Destinée aux carottages du béton armé, de la pierre naturelle et de l'asphalte

LIVRAISON

 Boîte cartonné comprenant :
 1 moteur de carotteuse
 1 bâti

METIERS

Chauffagiste, Installateur de climatiseur, Installateur sanitaire, Paysagiste

OUTILS

Nos couronnes S4 et S5



Carotteuse à eau DB200GR

Pour des carottages jusqu'au Ø 200 mm

RÉFÉRENCE	DB200GR
CARACTÉRISTIQUES TECHNIQUES	
Moteur	Electrique 230 V - 2500 W
Diamètre de carottage maxi à eau	200 mm
Raccord	1"1/4, 1/2"
Poids net	15,5 kg
Dimensions (L x l x h)	425 x 225,7 x 883 mm

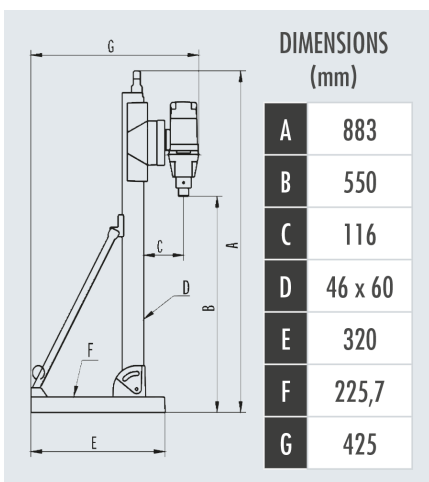

- Carotteuse à eau compacte
- Commutateur avec coupe circuit = protection contre la surcharge du moteur
- Boîte 1 vitesse à bain d'huile = lubrification optimale
- Charbons rupteurs = protection du moteur
- Débrayage mécanique de sécurité
- Dispositif d'arrivée d'eau intégré
- Raccord 1" 1/4 et 1/2"
- Légère, pratique, robuste et économique
- Bâti à embase mixte (kit ventouse en option) - inclinable jusqu'à 45°



Picto drapeau



1 vitesse



200 mm

EN OPTION

REFERENCE	DESCRIPTIF
CB-35730	Etai télescopique réglable de 1,70 à 3 m
CB-35450	Bague de dévissage en bronze 1"1/4
BDR1/4	Bague de dévissage rapide 1"1/4
CB-35022	Clé 22 pour couronne 1/2"
CB-35715000	Clé 32 de serrage/desserrage
CB-35041	Clé 41 pour couronne 1"1/4
CB-35710	Kit de fixation-tige filetée + écrous M12 x 200 + cheville M12
CB-35722	Cheville de fixation M12 Ø 15 mm pour kit CB-35710
CB-35851	Plaque ventouse universelle pour bâti Ø 162 mm max.
CB-3585F000	Kit ventouse complet
CB-35855000	Tuyau pour pompe à vide
CB-09380	Pompe à vide dépression max. 850 mbar, 25 l/min, Ø 200 mm
CB-35231	Raccord pour aspiration 1"1/4F- 1"1/4M (carottage à sec)
ASP-E16	Aspirateur pour eau et poussières 1600 W
ASP-E35L	Aspirateur eau et poussière 1200 W ; classe L
ASP-E35M	Aspirateur eau et poussière 1200 W ; classe M
CB-35810	Pulvérisateur acier 10 l.
CB-35811	Pulvérisateur PVC 10 l.
CB-35813	Pulvérisateur électrique 35 l.
CB-35814	Pulvérisateur dorsal électrique 15 l. avec 1 batterie
CB-35815	Pulvérisateur dorsal électrique 15 l. avec 2 batteries
CB-35876	Support d'aspiration universel Ø 162 mm maxi
CB-3586P	Support d'aspiration universel Ø 252 mm maxi
CB-35910	Pierre à affûter 210 x 140 x 50 mm
CB-35913000	Plaque d'affûtage 320 x 320 x 55 mm
SP0502	Rallonge monophasée ; 10 m ; L + N + T 16A ; 1,5 mm ²

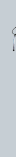

CB-35730



CB-35450

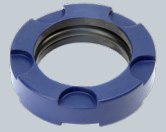

BDR1/4



CB-35022

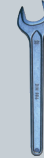

CB-35715000



CB-35041



CB-35710



CB-35722

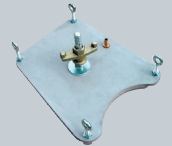

CB-35851



CB-3585F000



CB-35855000



CB-09380



CB-35231



ASP-E16



ASP-E35L



ASP-E35M



CB-35810



CB-35811



CB-35813



CB-35814



CB-35815

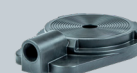

CB-35876

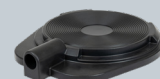

CB-3586P



CB-35910



CB-35913000



SP0502